

INSTALLATION GUIDE X40/X45



20

19

UNIVERSAL SYSTEMS **FOR FRAMELESS DOORS**

GENERAL INFORMATION

EU RECHTS | DROIT | RIGHT



Trekken EU rechts
Tirant EU droit
Pull EU right
Ziehen DIN Rechts



Duwen EU rechts
Poussant EU droit
Push EU right
Drücken DIN Rechts

EU LINKS | GAUCHE | LEFT

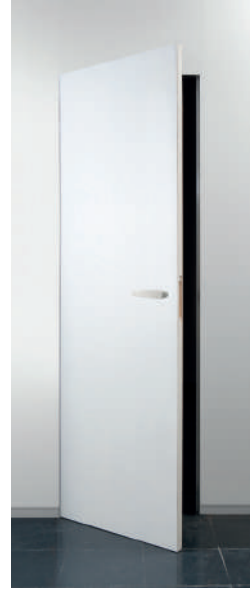

Trekken EU links
Tirant EU gauche
Pull EU left
Ziehen DIN Links



Duwen EU links
Poussant EU gauche
Push EU left
Drücken DIN Links



DEURFRAME

CADRE DE PORTE

DOOR FRAME

UNIVERSALZARGE

- 1** Staanders + bevestigingsprofielen
Montants + profilés de fixation
Uprights + fixing profiles
Pfosten + Befestigungsprofile

- 2** Kopstuk
Traverse
Upper rail
Querleiste

- 3** Afwerkingsprofiel XA-FIN *
Profil de finition *
Finishing profile *
Fertigungsprofil *



* Optioneel - Option
En option
XA-FIN 2200 x 120 x 9
XA-FIN 2600 x 120 x 9
XA-FIN 3000 x 120 x 9
XA-FIN 2200 x 260 x 9
XA-FIN 3000 x 260 x 9

XINNIX SELECTION DEURBESLAG

QUINCAILLERIE

HARDWARE

BESCHLÄGE

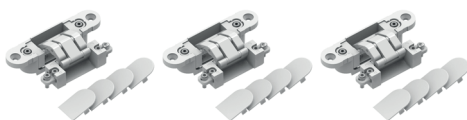

PROFILE CUT POSSIBILITIES

STOCK ITEMS

STANDARD WIDTH

630 680
 710 726 730 780
 810 818 826 830 880
 910 930 980
 1030

STANDARD HEIGHT

2015 2040
 2115
 2315

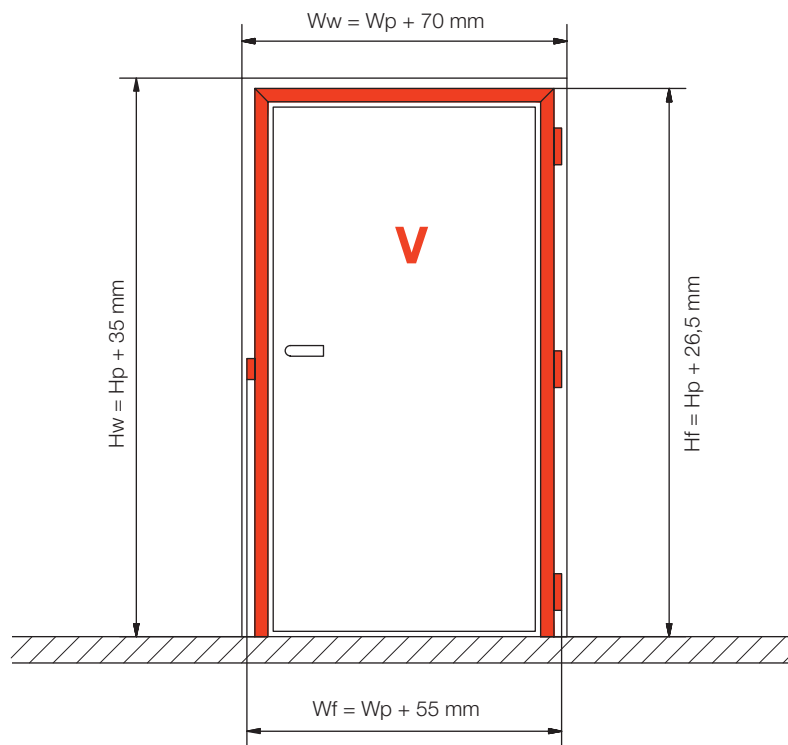
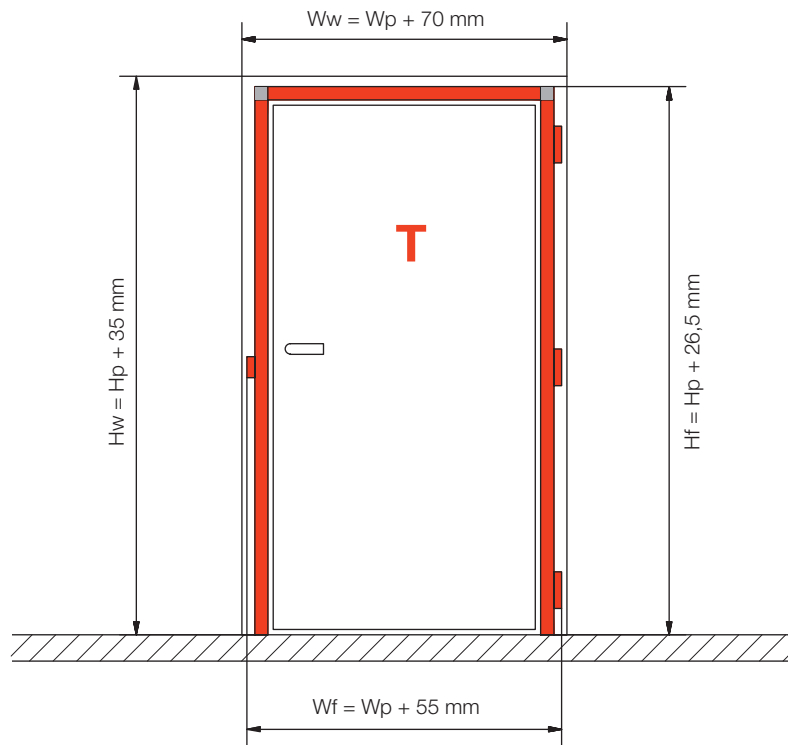

H_p = Height doorpanel (max 3000mm)
 W_p = Width doorpanel

H_f = Height doorframe
 W_f = Width doorframe

H_w = Opening height wall
 W_w = Opening width wall

FRAME TYPE T

1X FRAME = 8 POSITIONS



**DUWEN / TREKKEN
POUSSANT / TIRANT
PUSH / PULL
DRÜCKEN / ZIEHEN**

**EU RECHTS / EU LINKS
EU DROIT / EU GAUCHE
EU RIGHT / EU LEFT
EU RECHTS / EU LINKS**

INSTALLATION **PULL** EU LEFT

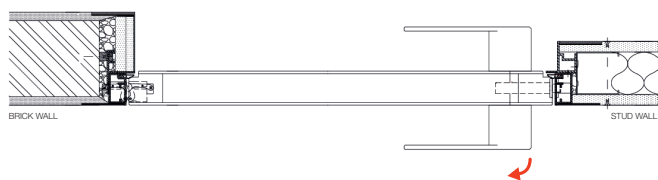
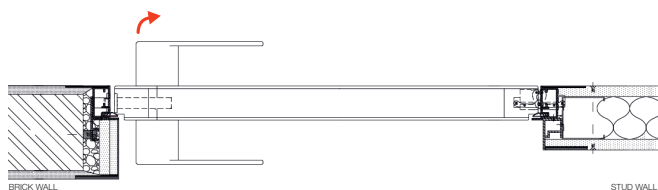

INSTALLATION **PULL** EU RIGHT

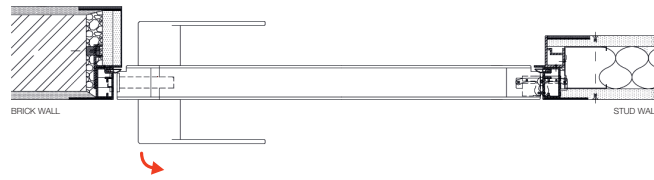
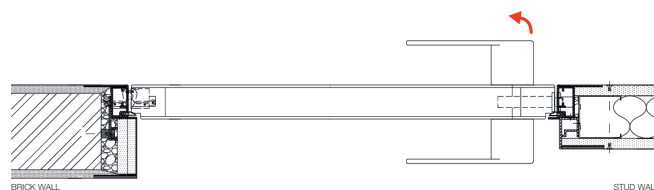

INSTALLATION **PUSH** EU LEFT

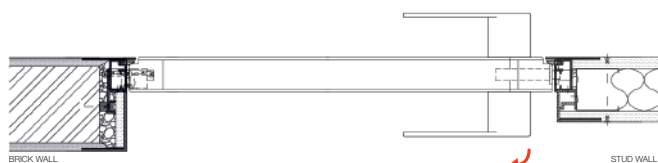

INSTALLATION **PUSH** EU RIGHT



EXPLODED VIEW TYPE T **FU** - UNIVERSAL FIXING

EU LEFT FLUSH PULL INSTALLATION

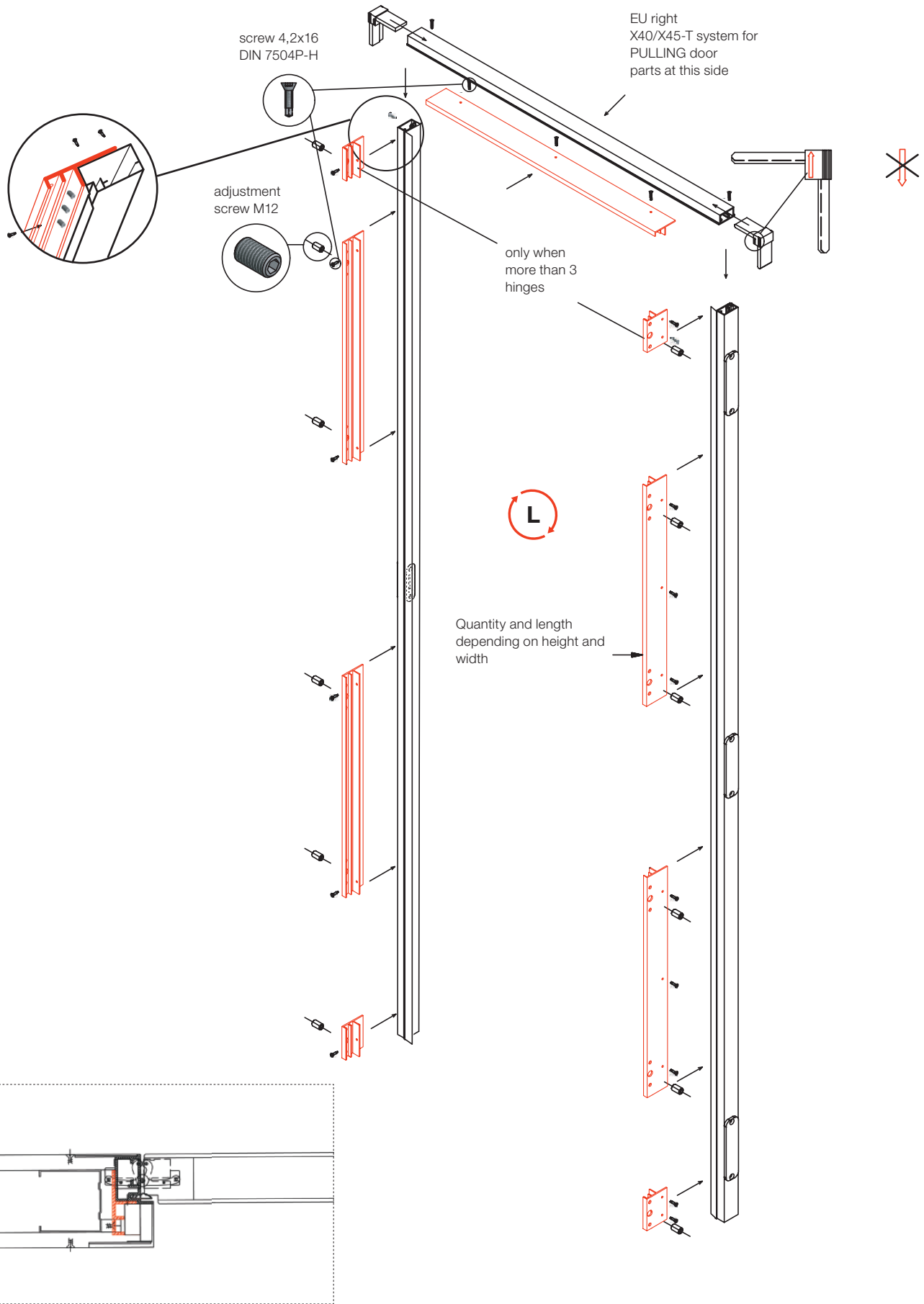

EXPLODED VIEW - TYPE T **FU** - UNIVERSAL FIXING

EU RIGHT FLUSH PUSH INSTALLATION

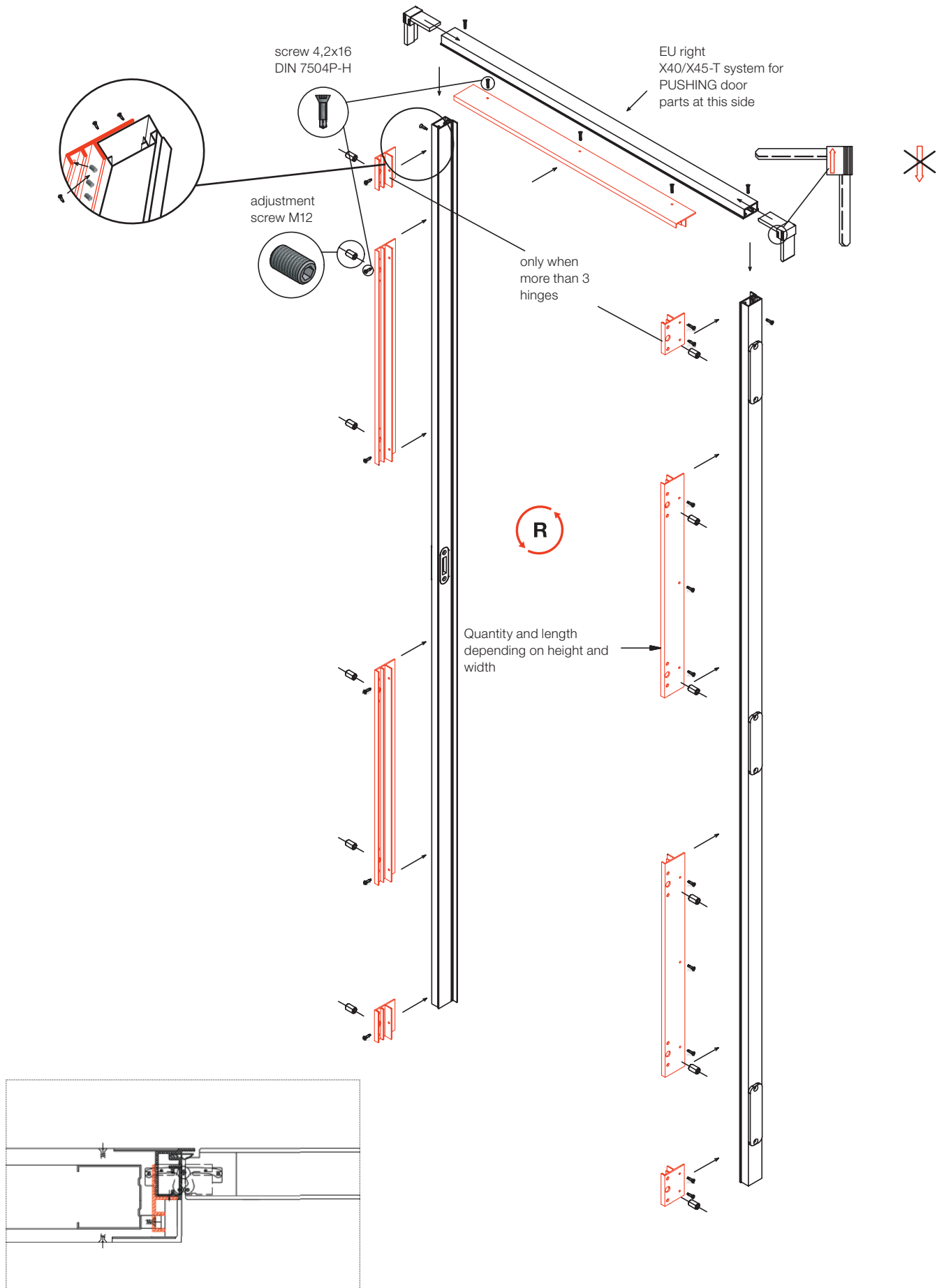

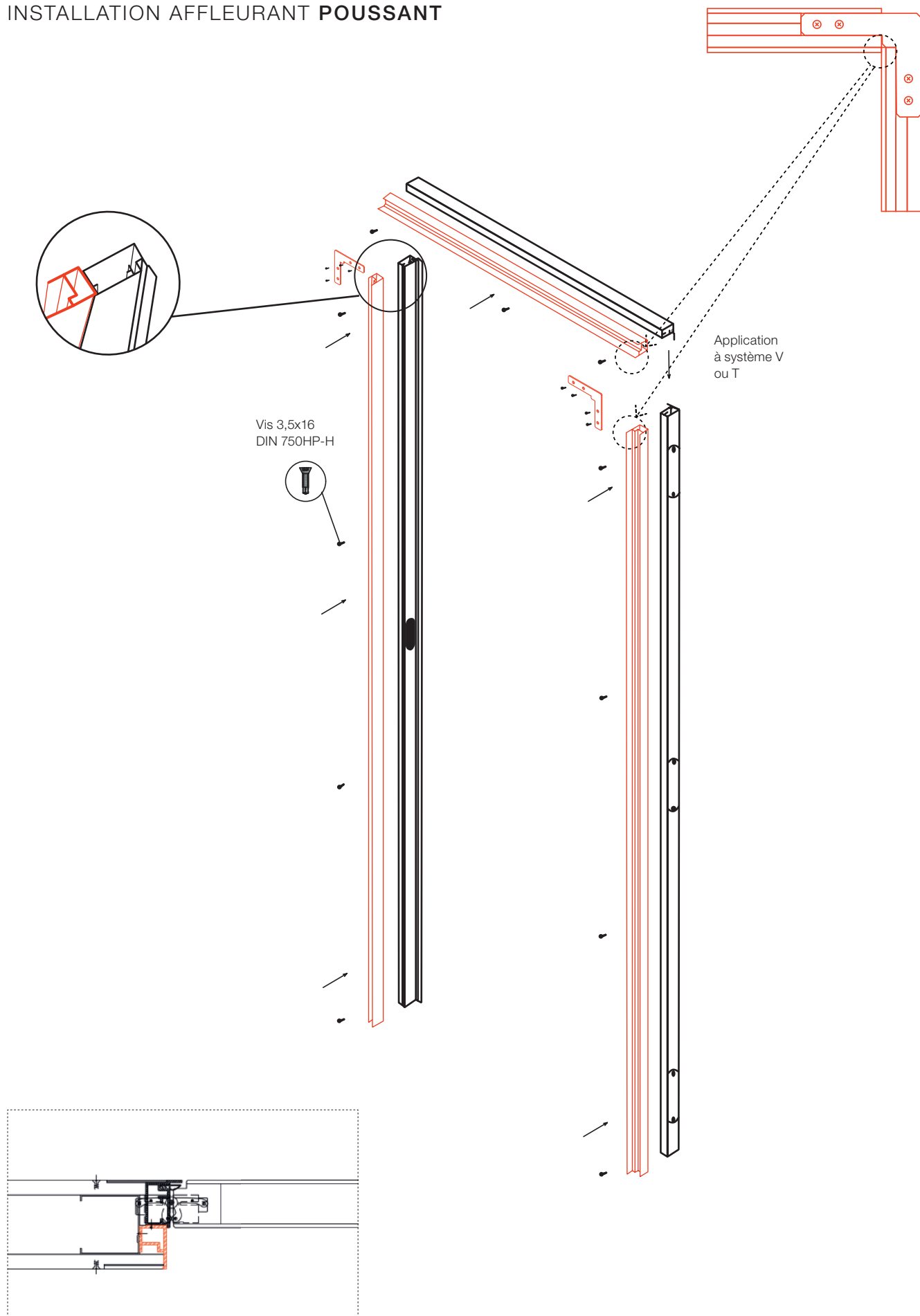
EU DROITE
INSTALLATION AFFLEURANT **POUSSANT**

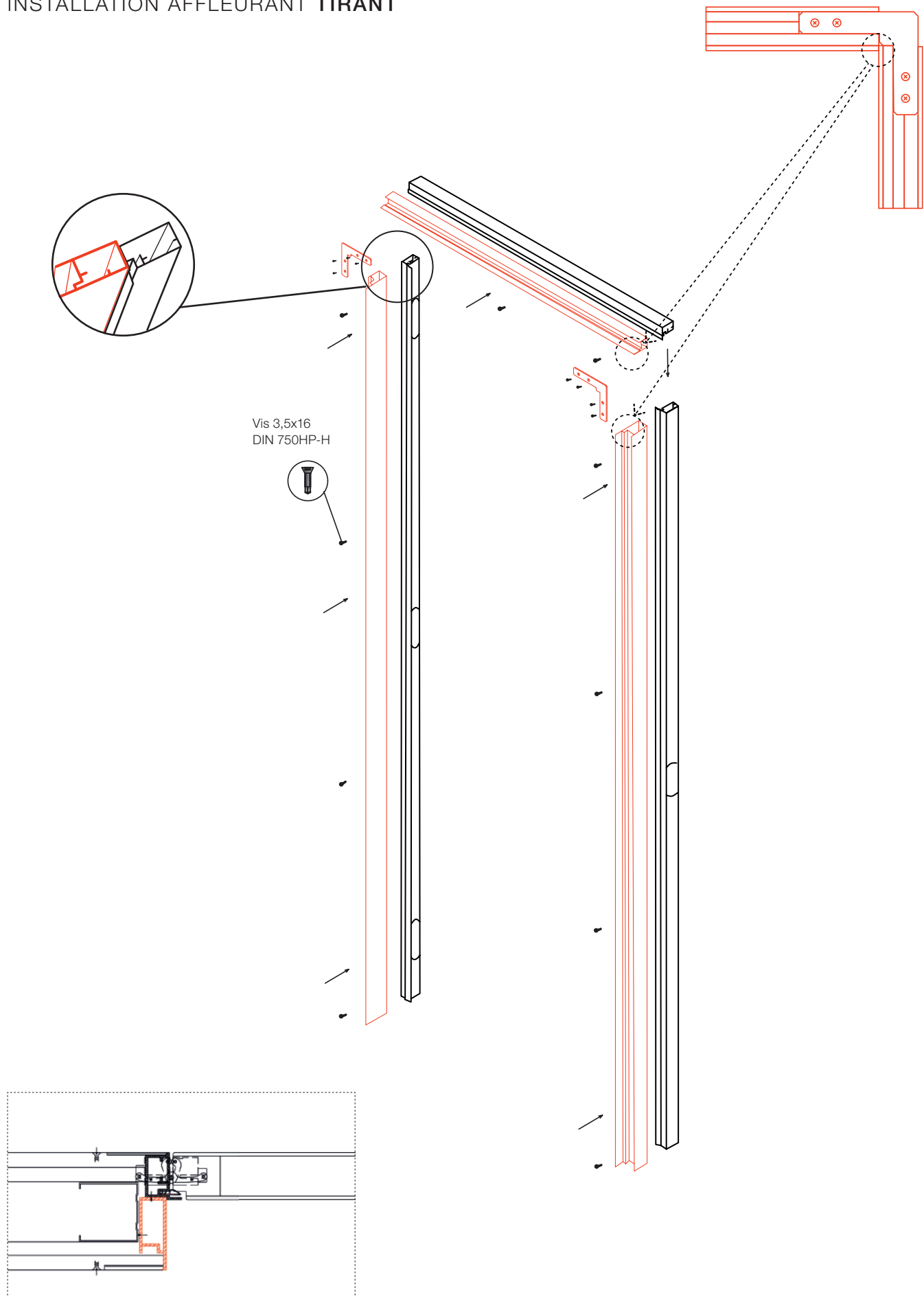
EU DROITE
INSTALLATION AFFLEURANT TIRANT

FRAME TYPE V

1x **EU L**



DUWEN / TREKKEN LINKS
 POUSSANT / TIRANT GAUCHE
 PUSH / PULL LEFT
 DRÜCKEN / ZIEHEN LINKS



INSTALLATION **PULL** EU LEFT

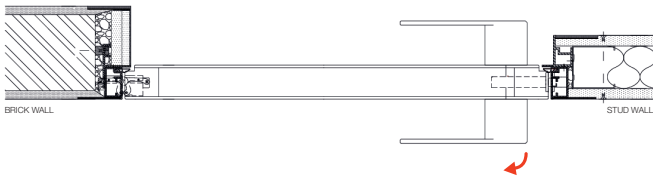
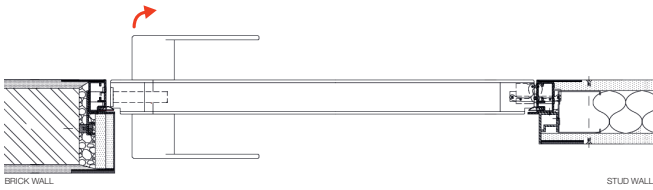

INSTALLATION **PUSH** EU LEFT



1x **EU R**



DUWEN / TREKKEN RECHTS
 POUSSANT / TIRANT DROIT
 PUSH / PULL RIGHT
 DRÜCKEN / ZIEHEN RECHTS

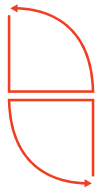

INSTALLATION **PULL** EU RIGHT

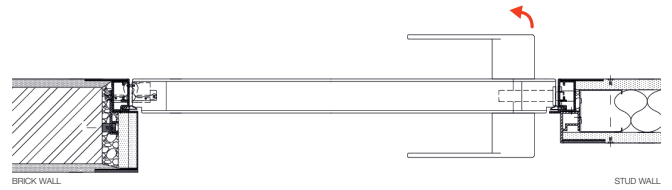

INSTALLATION **PUSH** EU RIGHT



INSTALLATION STEPS



Na het samenvoegen van de X40 elementen is het deurgeheel klaar voor montage in de wand.

Après l'assemblage de la huisserie autour de la porte, l'ensemble X40 est prêt pour installation dans la cloison.

After merging the X40 elements the door and frame are ready for installation in the wall.

Nach dem Zusammenführen der X40-Elemente ist alles fertig zum montieren im Wand.

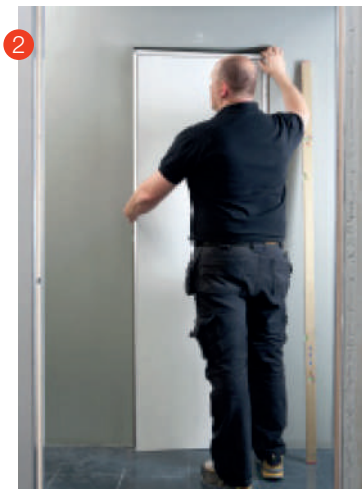

Zet het deurgeheel in de wand.

Installez l'ensemble dans la cloison.

Install the door and frame in the wall.

Montier das Türblatt mit die Zargen im Wand.



Controleer of deur en frame in lijn liggen met de wand.

Contrôlez la linéarité de la porte avec le mur.

Check if the door is perfectly in line with the wall.

Überprüf ob das Türblatt mit den Wand ausgerichtet ist.

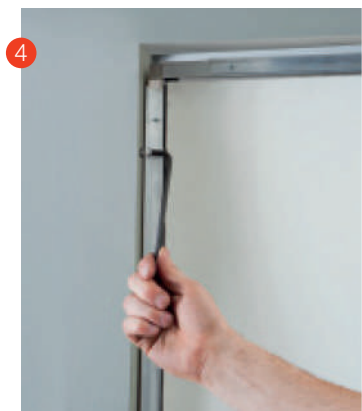

Met de stelschroeven kan u het deurgeheel waterpas stellen.

Ajustez l'ensemble en utilisant les vis d'ajustage.

Adjust the door frame using the adjustment screws.

Das Türblatt nachstellen mit die Stellschrauben.

INSTALLATION STEPS



Bevestig het geheel met schroeven in de wand.

Fixez l'ensemble avec des vis dans la cloison.

Screw the door frame with the appropriate screws in the wall.

Schraub alles fest mit Schrauben im Wand.



Fixeer met PUR-schuim.

Fixez l'ensemble avec de la mousse PUR.

Fix with PUR foam.

Fixier mit PUR Schäume.

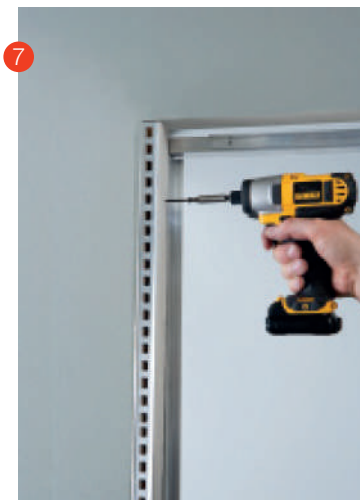

Werk de achterzijde af in lijn met de muurdikte.

Finir l'épaisseur du mur aligné avec le mur.

Finish the wall thickness according the finished wall.

Fertig die Hintenseide ausgerichtet mit den Wand.

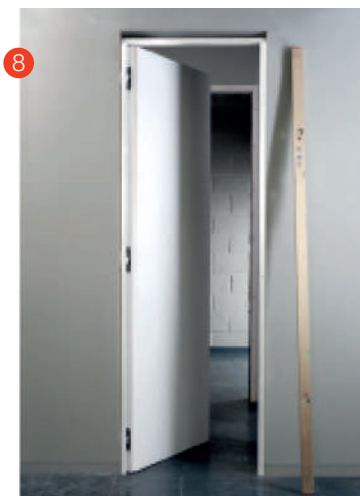

Onze deur is klaar voor gebruik.

La porte est prête à l'emploi.

The door is ready to be used.

Das Türblatt ist fertig zum benutzen.

XP50[®] - UNIVERSAL INTEGRATED XINNIX PLINTH

XP50

- a** X40
- b** XP50-C002
- c** XP50 + XP50-Cover
- d** XP50-C001
- e** XP50-A045 (+45° / -45°)

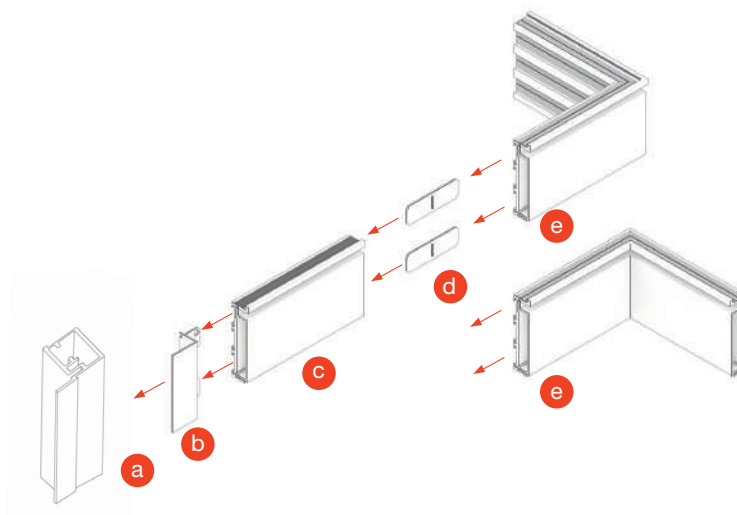

XP50-04

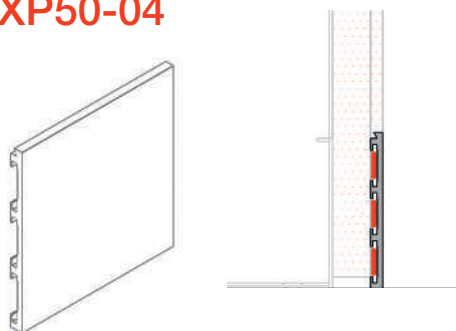

MINIMALISTIC PLINTH FOR FLUSH INSTALLATION

- All installation and adjustment pieces are available
- Glued invisible in the wall construction
- Dimensions: 50 x 4 mm

BESTELCODE	OMSCHRIJVING
XP50.04-3000.W	Plinth 3000 mm - White primer

X40/X45 - FINISHING PROFILE

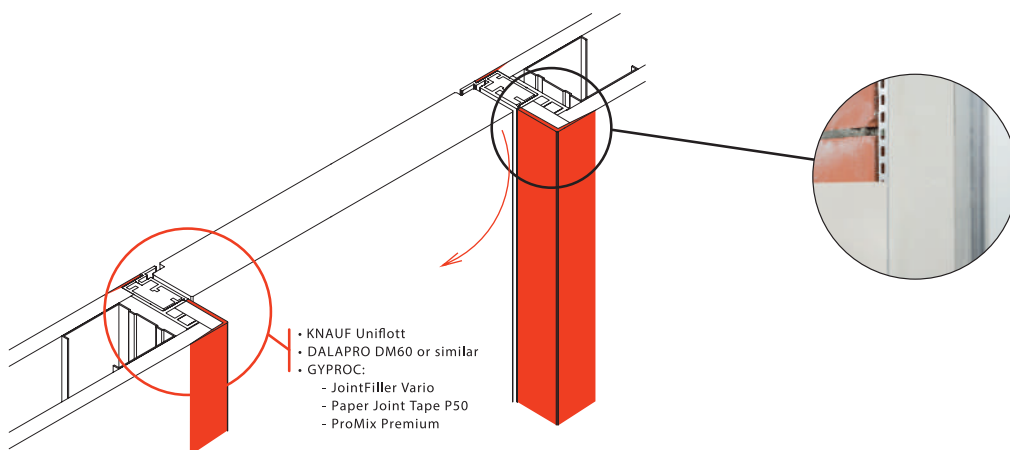

POSSIBLE DIMENSIONS

ORDER CODE
XA-FIN2200/120
XA-FIN2200/120
XA-FIN2600/120
XA-FIN3000/120
XA-FIN3000/260

PACKAGINGS IN DOOR SETS

ORDER CODE
XA-KFIN2088/140/KE1
XA-KFIN2200/120/KE1
XA-KFIN2200/120/KE1
XA-KFIN2600/120/KE1
XA-KFIN2600/120/KE2

HARDWARE



XA-D70BB.CS	🔑
XA-D73WC.CS	🔍
XA-D78PZ.CS	🔑
XA-D80BB.CS	🔑
XA-D83WC.CS	🔍
XA-D89PZ.CS	🔑

!HANDLE HEIGHT CHANGES!



DIN (X45)

XA-KFV116F	
XA-KFV116BB	🔑
XA-KFV116WC	🔍
XA-KFV116PZ	🔑

!HANDLE HEIGHT CHANGES!



XA-937

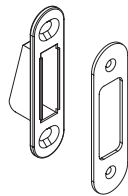

XA-998NH.CS



XA-NH003I



XA-NZ.G



XA-NZ.B



XA-NH004M
XA-NH006M



XA-NZ.W



XA-I98.CS

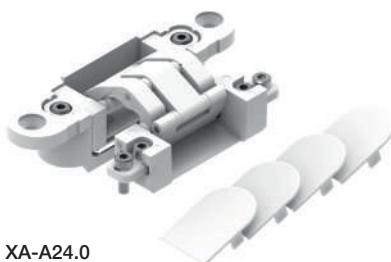

XA-A24.0
WIT | BLANC | WHITE | WEIß
Xinnix Selection

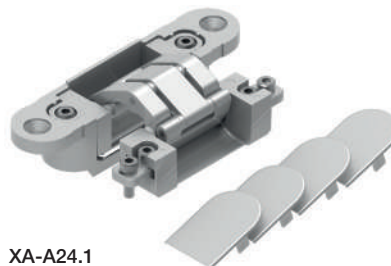

XA-A24.1
ALU F1
Xinnix Selection

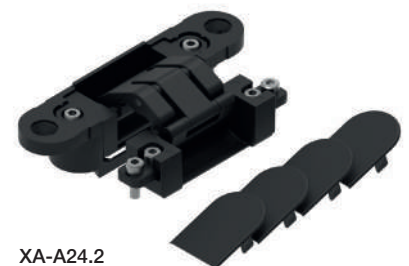

XA-A24.2
ZWART | NOIR | BLACK | SCHWARZ
Xinnix Selection



Generaal Deprezstraat 2/010
8530 Harelbeke - Belgium

Tel.: +32 (0) 56 73 50 00
Fax: +32 (0) 56 72 02 70

info@xinnix.eu
www.xinnix.eu